

Struttura: alluminio a gravità e pressofuso.

Diffusore: in vetro soffiato, vetro a lastra.

A richiesta globo in PMMA.

Lampada: incandescenza, compatte integrate ed a luce miscelata.

Viteria: inox.

Cablaggio: portalampade porcellana E27, fili in teflon, morsetti in nylon.

Trattamento: anticorrosivo, elettroforesi catodica.

Verniciatura: polveri poliesteri.

Structure: gravity diecast and diecast aluminium.

Diffuser: blown or panel glass. PMMA globe available.

Bulb: incandescent, integrated compact and blended mercury bulbs.

Fasteners: stainless steel.

Wiring: E27 porcelain lampholder, teflon covered wires, nylon terminal block.

Coating: anti-corrosion, cathodic electrophoretic.

Paint finish: polyester powder.

Struktur: Aluminium-Schwerkraftguss und-druckguss.

Diffusor: geblasenes Glas oder Glasscheiben.

PMMA-Kugel verfügbar.

Lampe: Glühlampen, kompakt integriert und Mischlichtlampen.

Schrauben: Edelstahl.

Verkabelung: Porzellan-Lampenfassung E27, Teflonleitungen, Klemmleiste aus Nylon.

Behandlung: Korrosionsschutz, kathodische Elektrophorese.

Lackierung: Polyesterpulver.

Structure: aluminium à gravité et moulé sous pression.

Diffuseur: verre soufflé ou plaque. Boule PMMA sur demande.

Ampoule: à incandescence, compactes intégrées et mercure mixte.

Vis: inox.

Câblage: douille porcelaine E27, fils téflon, bornier nylon.

Traitement: anticorrosion, électrophorèse cathodique.

Peinture: poudres polyester.

Estructura: aluminio por gravedad y fundido a presión.

Difusor: vidrio soplado o laminado. Globo PMMA sobre pedido.

Bombilla: incandescencia, compactas integradas y de luz mezcla.

Tornillería: inox.

Cableado: portalámparas porcelana E27, hilos con teflon, bornera en nylon.

Tratamiento: anticorrosivo, electroforesis catódica.

Pintado: polvos poliésteres.



IP44 ▲ ▼ CE
 E27 Classe I
 IAA 150W
 FBT 27W
 QB 100W

PMMA ●
 IP44 ▲ ▼ CE
 E27 Classe I
 IAA 60W
 FBT 23W

31020 → **310202**
 Ø 55 → Ø 60

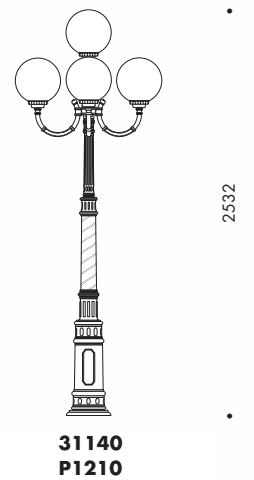
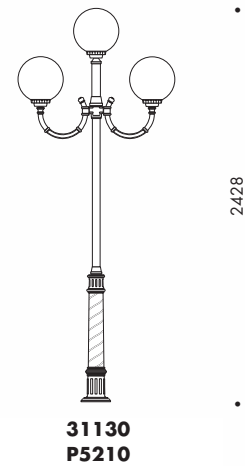
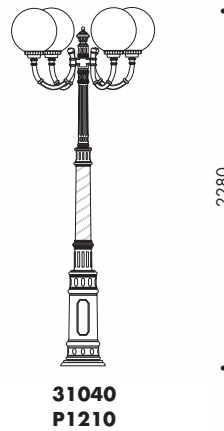
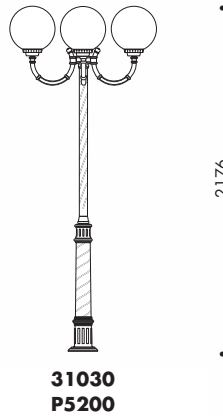
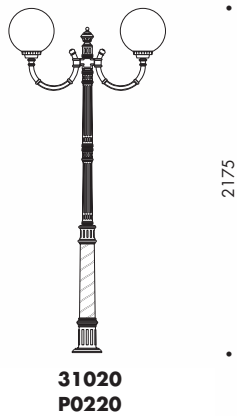
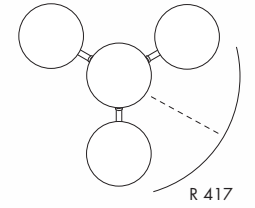
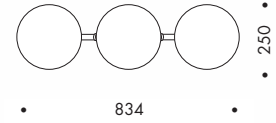
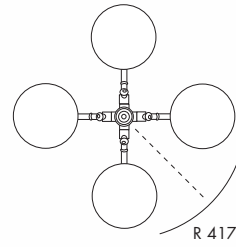
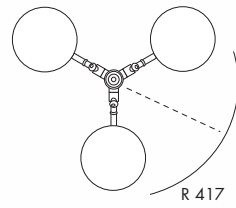
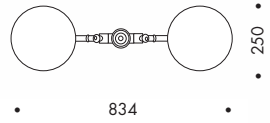
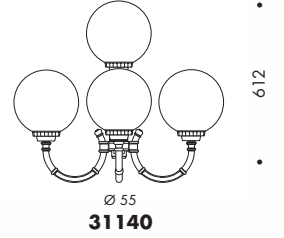
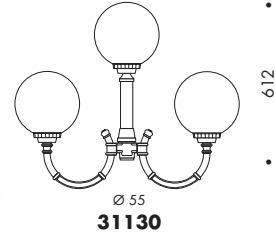
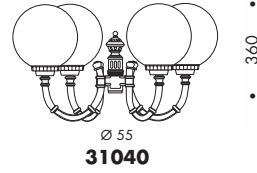
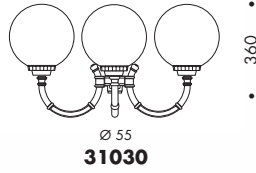
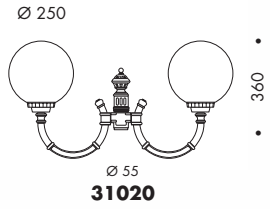



IP44 ▲ ▼ CE
E27 Classe I
IAA 150W
FBT 27W
QB 100W

PMMA ●
IP44 ▲ ▼ CE
E27 Classe I
IAA 60W
FBT 23W

31023 → **310232**
Ø 55 → Ø 60

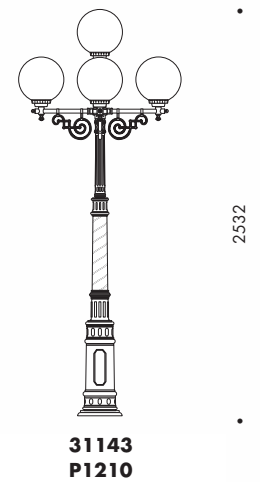
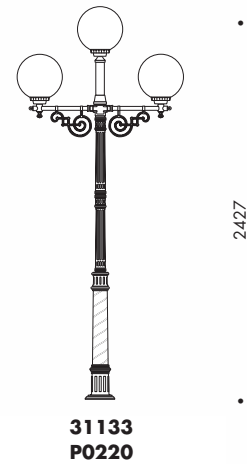
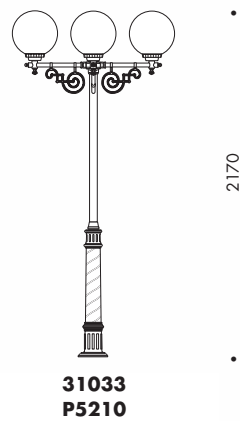
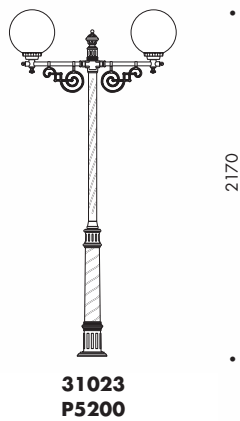
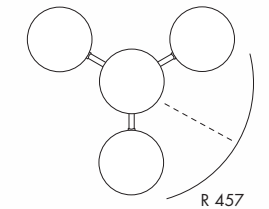
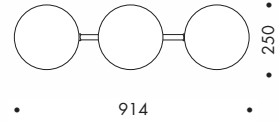
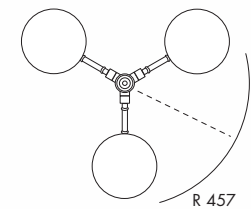
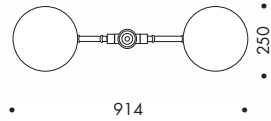
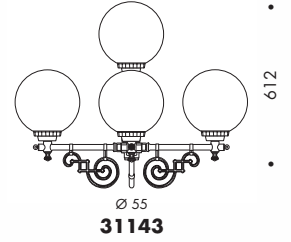
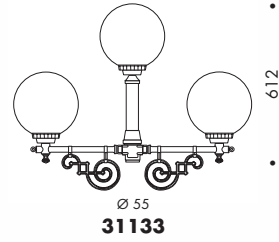
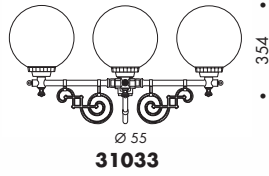
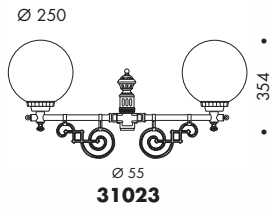

IP44 ▲ ▼ CE ⊕
 E27 Classe I ⊕
 IAA 150W 
 FBT 27W 
 QB 100W 

312P4 → **312P43**
 Ø 60 Ø 55

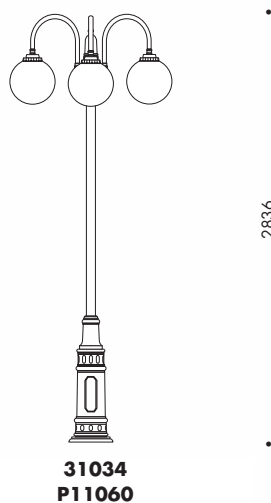
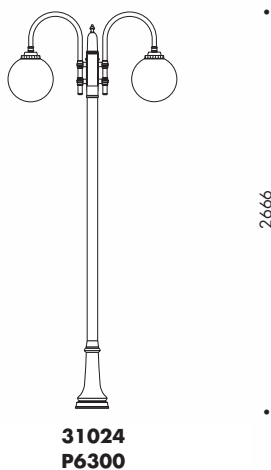
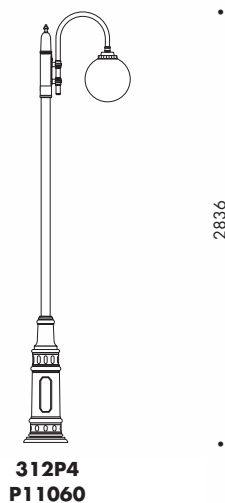
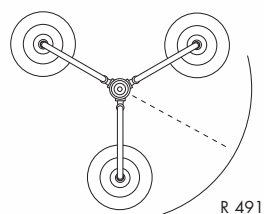
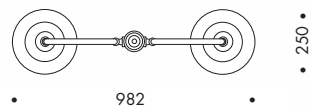
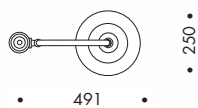
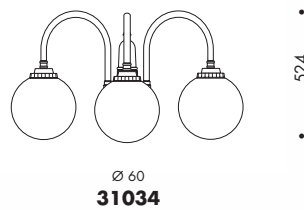
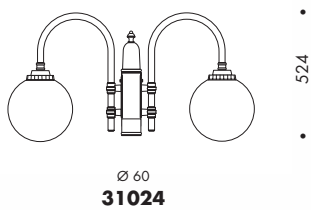
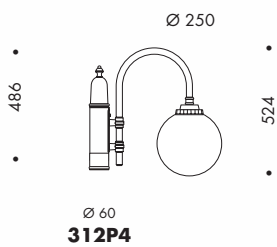

IP44 ▲ ▼ CE Ⓜ
 E27 Classe I ⊕
 IAA 150W ⚡
 FBT 27W ⚡
 QB 100W ⚡

PMMA ●
 IP44 ▲ ▼ CE
 E27 Classe I ⊕
 IAA 60W ⚡
 FBT 23W ⚡

312P2 → **312P23**
 Ø 60 → Ø 55

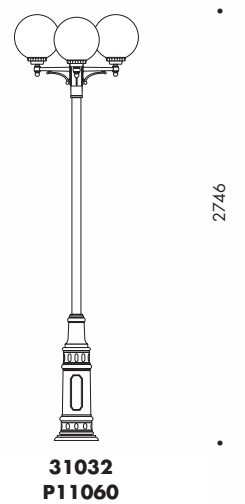
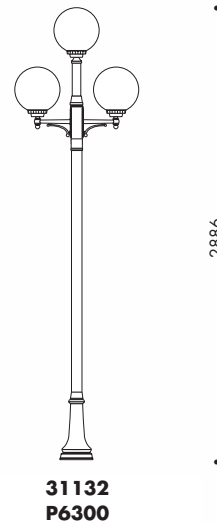
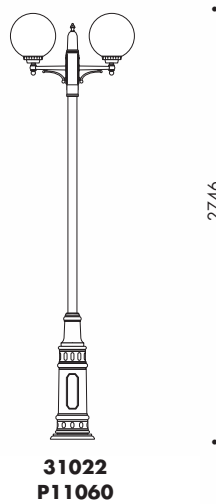
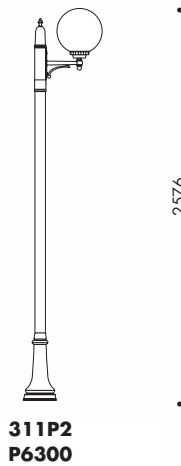
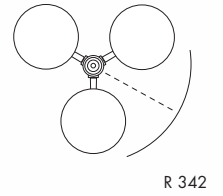
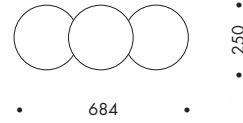
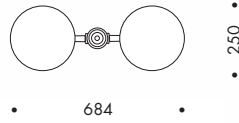
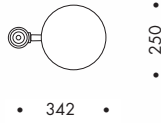
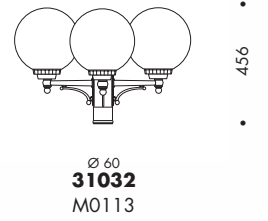
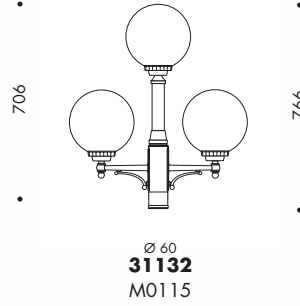
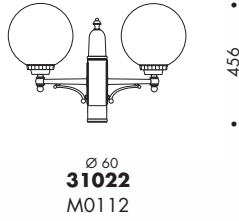
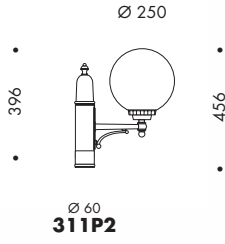



IP23
 IP43 con fondello in
 policarbonato trasparente
 E27 Classe I
 IAA 150W
 FBT 27W
 QB 100W

50020 → **500202**
 Ø 55 → Ø 60

I modelli sono intercambiabili, per una migliore comprensione delle
 composizioni abbiamo esemplificato usando il modello 50.
 È possibile avere gli stessi gruppi ottici con i modelli
 51/52/53/54/55/56/57/58/59/70.

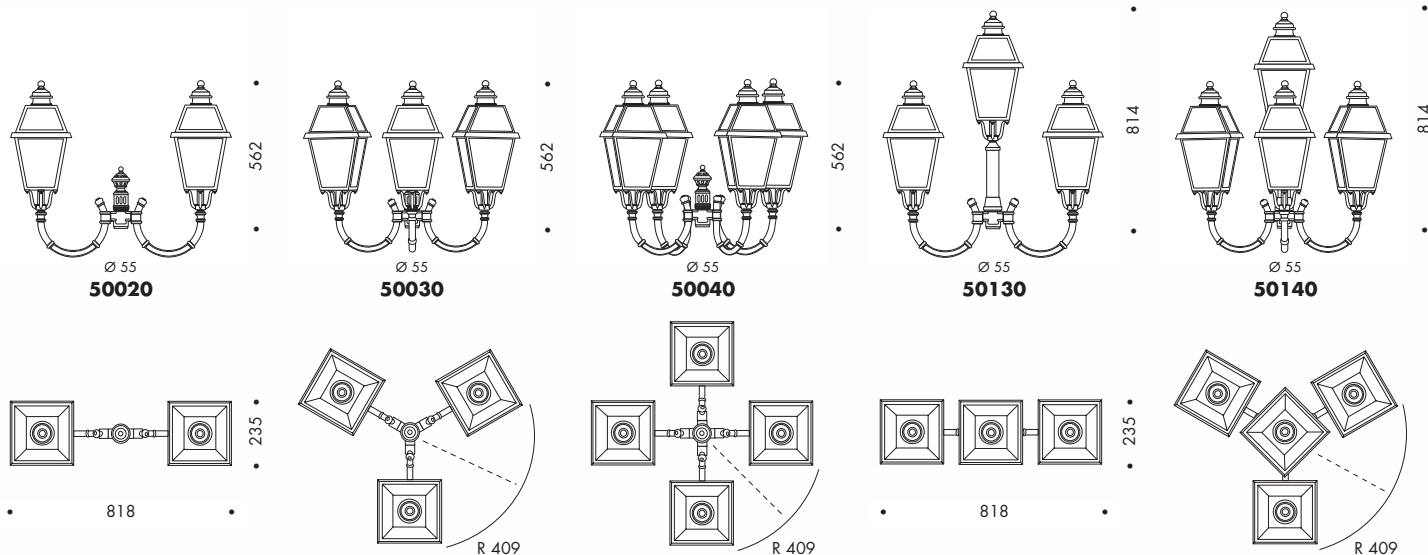

Heads are interchangeable, for a better
 comprehension we suggested model
 50 but arrangements are available
 with all models
 51/52/53/54/55/56/57/58/59/70.

Im Katalog haben wir zur
 Vereinfachung die Modelle 50, als
 Beispiel, abgebildet.
 Es können jedoch auch die Modelle
 51/52/53/54/55/56/57/58/59/70
 verwendet werden.

Les modèles sont interchangeables,
 pour simplifier nous avons présenté le
 modèle 50 mais la même application
 peut se faire avec les modèles
 51/52/53/54/55/56/57/58/59/70.

Los modelos son intercambiables.
 Para una mejor comprensión de las
 composiciones, hemos realizado un
 ejemplo con el modelo 50.
 Es posible tener los mismos grupos
 ópticos con los modelos
 51/52/53/54/55/56/57/58/59/70.

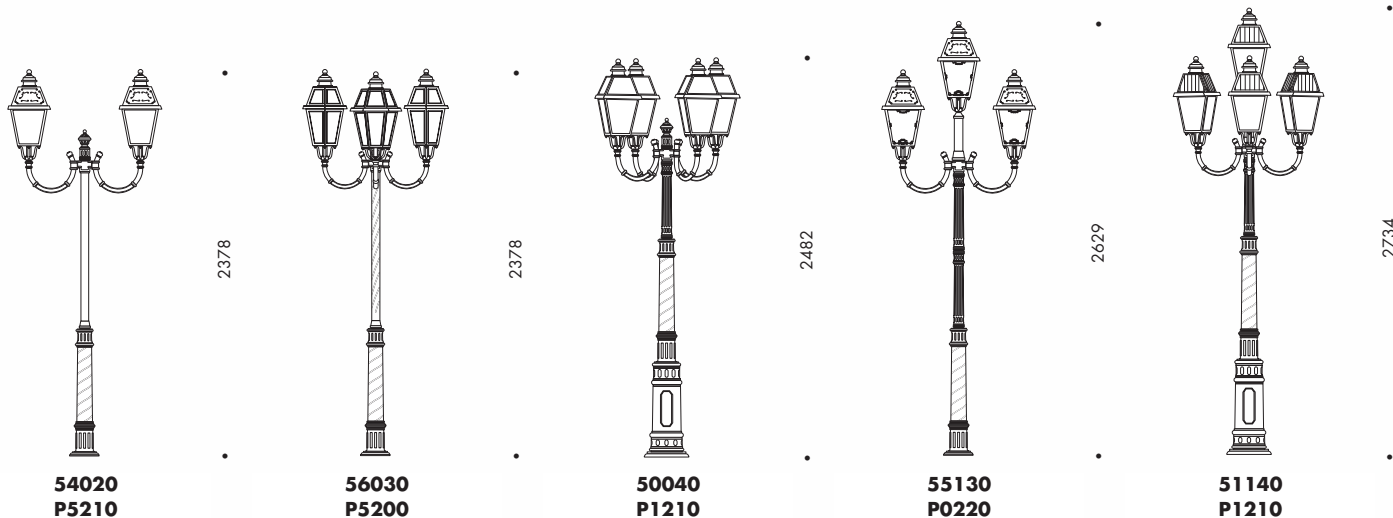

IP23
 IP43 con fondello in
 policarbonato trasparente
 E27 Classe I
 IAA 150W
 FBT 27W
 QB 100W

I modelli sono intercambiabili, per una migliore comprensione delle
 composizioni abbiamo esemplificato usando il modello 50.
 È possibile avere gli stessi gruppi ottici con i modelli
 51/52/53/54/55/56/57/58/59/70.

50023 → **500232**
 Ø 55 Ø 60

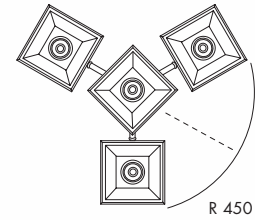
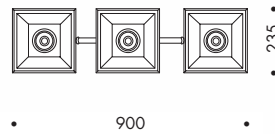
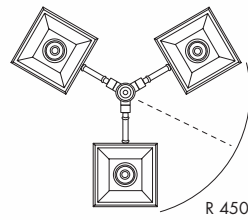
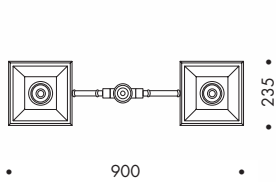
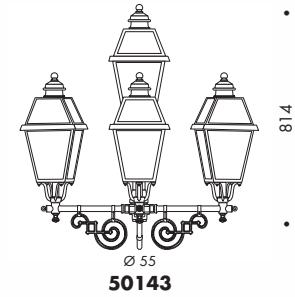
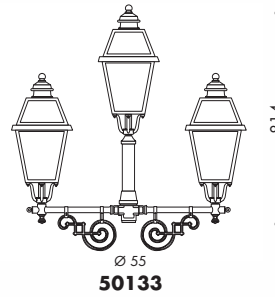
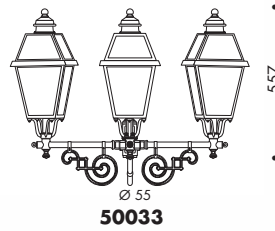
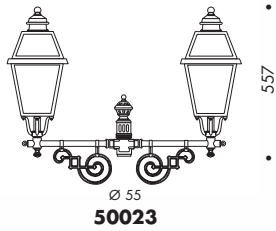

Heads are interchangeable, for a better
 comprehension we suggested model
 50 but arrangements are available
 with all models
 51/52/53/54/55/56/57/58/59/70.

Im Katalog haben wir zur
 Vereinfachung die Modelle 50, als
 Beispiel, abgebildet.
 Es können jedoch auch die Modelle
 51/52/53/54/55/56/57/58/59/70
 verwendet werden.

Les modèles sont interchangeables,
 pour simplifier nous avons présenté le
 modèle 50 mais la même application
 peut se faire avec les modèles
 51/52/53/54/55/56/57/58/59/70.

Los modelos son intercambiables.
 Para una mejor comprensión de las
 composiciones, hemos realizado un
 ejemplo con el modelo 50.
 Es posible tener los mismos grupos
 ópticos con los modelos
 51/52/53/54/55/56/57/58/59/70.

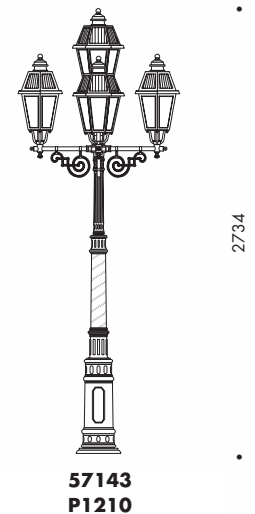
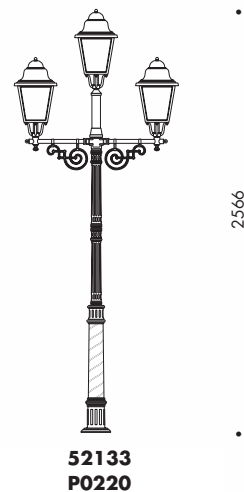
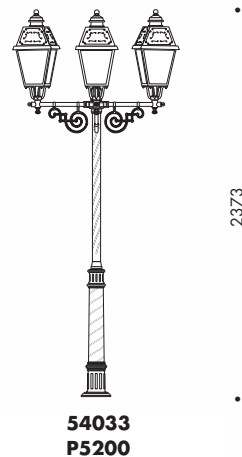
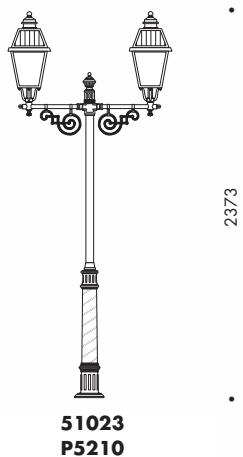

IP23
 IP43 con fondello in
 policarbonato trasparente
 E27 Classe I
 IAA 150W
 FBT 27W
 QB 100W

502P4 → **502P43**
 Ø 60 → Ø 55

I modelli sono intercambiabili, per una migliore comprensione delle
 composizioni abbiamo esemplificato usando il modello 50.
 È possibile avere gli stessi gruppi ottici con i modelli
 51/52/53/54/55/56/57/58/59/70.

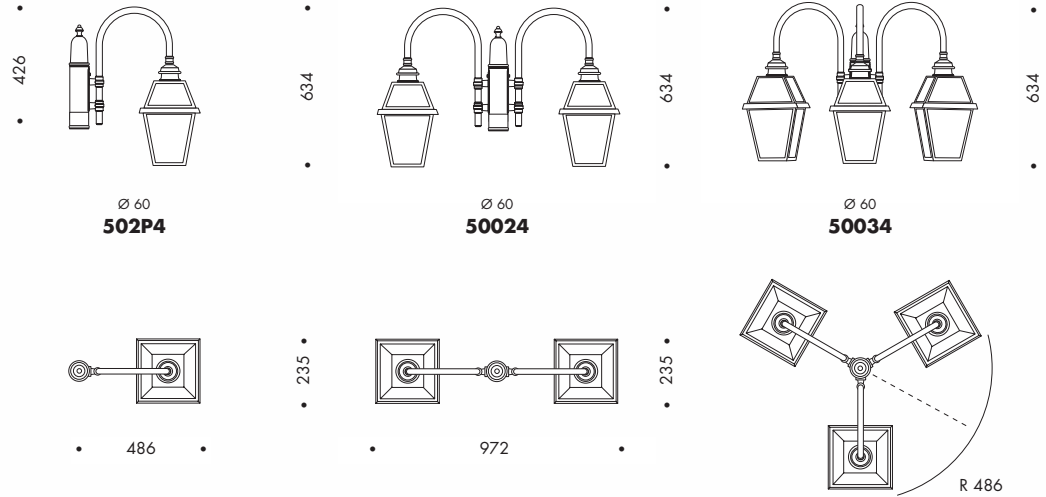

Heads are interchangeable, for a better
 comprehension we suggested model
 50 but arrangements are available
 with all models
 51/52/53/54/55/56/57/58/59/70.

Im Katalog haben wir zur
 Vereinfachung die Modelle 50, als
 Beispiel, abgebildet.
 Es können jedoch auch die Modelle
 51/52/53/54/55/56/57/58/59/70
 verwendet werden.

Les modèles sont interchangeables,
 pour simplifier nous avons présenté le
 modèle 50 mais la même application
 peut se faire avec les modèles
 51/52/53/54/55/56/57/58/59/70.

Los modelos son intercambiables.
 Para una mejor comprensión de las
 composiciones, hemos realizado un
 ejemplo con el modelo 50.
 Es posible tener los mismos grupos
 ópticos con los modelos
 51/52/53/54/55/56/57/58/59/70.

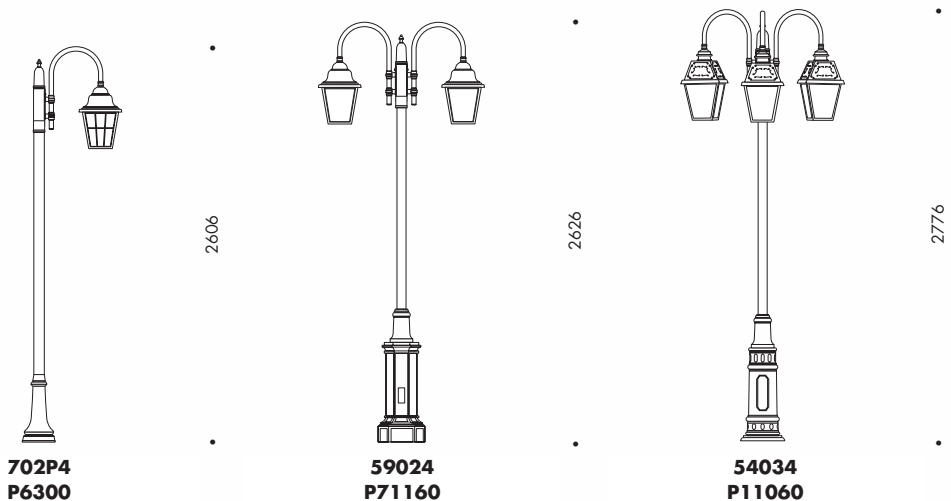



IP23
 IP43 con fondello in
 policarbonato trasparente
 E27 Classe I
 IAA 150W
 FBT 27W
 QB 100W

501P2 → **501P23**
 Ø 60 Ø 55

I modelli sono intercambiabili, per una migliore comprensione delle
 composizioni abbiamo semplificato usando il modello 50.
 È possibile avere gli stessi gruppi ottici con i modelli
 51/52/53/54/55/56/57/58/59/70.

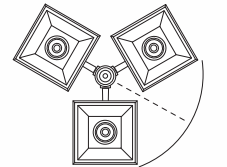
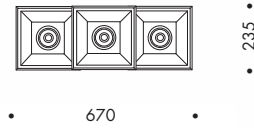
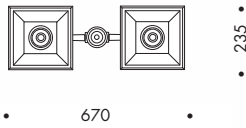
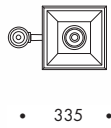
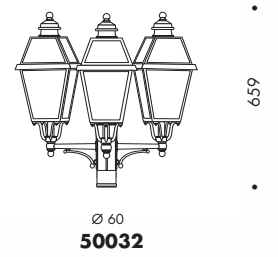
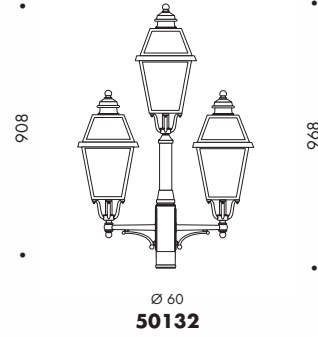
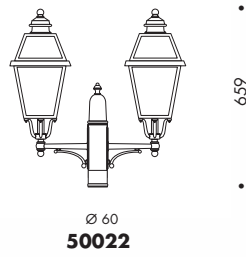
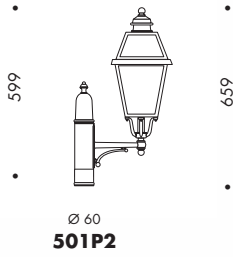

Heads are interchangeable, for a better
 comprehension we suggested model
 50 but arrangements are available
 with all models
 51/52/53/54/55/56/57/58/59/70.

Im Katalog haben wir zur
 Vereinfachung die Modelle 50, als
 Beispiel, abgebildet.
 Es können jedoch auch die Modelle
 51/52/53/54/55/56/57/58/59/70
 verwendet werden.

Les modèles sont interchangeables,
 pour simplifier nous avons présenté le
 modèle 50 mais la même application
 peut se faire avec les modèles
 51/52/53/54/55/56/57/58/59/70.

Para una mejor comprensión de las
 composiciones, hemos realizado un
 ejemplo con el modelo 50.
 Es posible tener los mismos grupos
 ópticos con los modelos
 51/52/53/54/55/56/57/58/59/70.

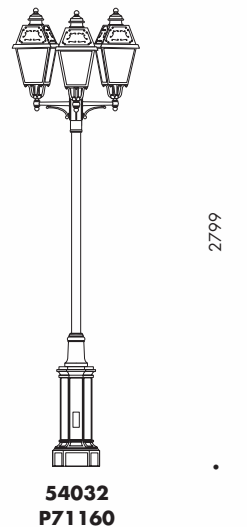
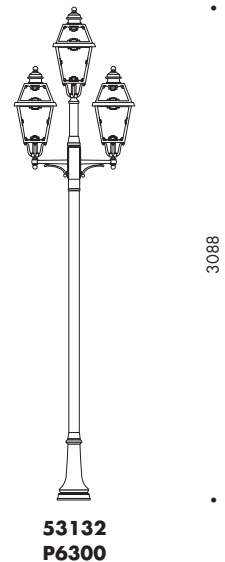
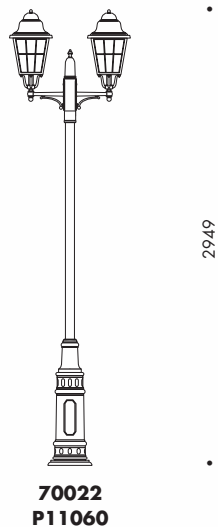
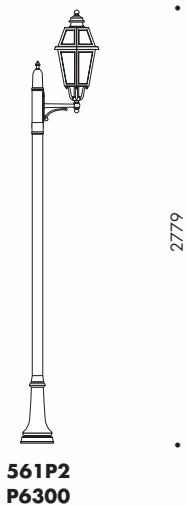

IP23
 IP43 con fondello in
 policarbonato trasparente
 E27 Classe I
 IAA 150W
 FBT 27W
 QB 100W

I modelli sono intercambiabili, per una migliore comprensione delle
 composizioni abbiamo esemplificato usando il modello 58.
 È possibile avere gli stessi gruppi ottici con i modelli 59/70.

582P9 → **582P93**
 Ø 60 Ø 55

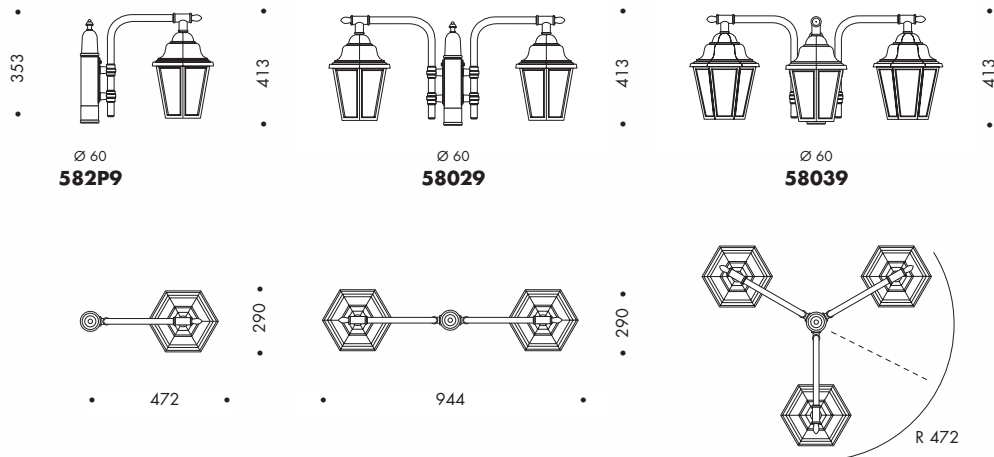

Heads are interchangeable, for a better
 comprehension we suggested model
 58 but arrangements are available
 with all models 59/70.

Im Katalog haben wir zur
 Vereinfachung die Modelle 58, als
 Beispiel, abgebildet.
 Es können jedoch auch die Modelle
 59/70 verwendet werden.

Les modèles sont interchangeables,
 pour simplifier nous avons présenté le
 modèle 58 mais la même application
 peut se faire avec les modèles
 59/70.

Los modelos son intercambiables.
 Para una mejor comprensión de las
 composiciones, hemos realizado un
 ejemplo con el modelo 58.
 Es posible tener los mismos grupos
 ópticos con los modelos 59/70.

