

Diffusore Diffuser
Diffuseur Difusor



Struttura: alluminio a gravità, pressofuso, estruso, a lastra.

Diffusore: policarbonato.

Lampada: incandescenza, compatte integrate, a scarica, led.

Viteria: inox.

Cablaggio: portalampe porcellana E27, fili in teflon, morsettiera in nylon. A richiesta accessori per lampade a scarica.

Trattamento: anticorrosivo, elettroforesi catodica.

Verniciatura: polveri poliesteri.

Applicazione: a muro con scatola e viti di fissaggio, a soffitto, a palo singola e gruppi.

Structure: gravity diecast and diecast aluminium, extruded aluminium and aluminium plate.

Diffuser: polycarbonate.

Bulb: incandescent, integrated compact, discharge lamps, led lamp.

Fasteners: stainless steel.

Wiring: E27 porcelain lampholder, teflon covered wires, nylon terminal block. Accessories for discharge lamps available.

Coating: anti-corrosion, cathodic electrophoretic.

Paint finish: polyester powder.

Applications: wall-mounted with box and fixing screws, ceiling-mounted, single or multiple for posts.

Struktur: Aluminium-Schwerkraftguss und-druckguss, gepresstes Aluminium und Aluplatte.

Diffusor: polycarbonat.

Lampe: Glühlampen, kompakt integriert, Metaldampflampen, Leuchten.

Schrauben: Edelstahl.

Verkabelung: Porzellan-Lampenfassung E27, Teflonleitungen, Klemmleiste aus Nylon. Metaldampflampenzubehör verfügbar.

Behandlung: Korrosionsschutz, kathodische Elektrolyse.

Lackierung: Polyesterpulver.

Anwendung: Wandinstallation mit Gehäuse und Befestigungsschrauben, Deckeninstallation, Mast-Einzelleuchte oder -gruppen.

Structure: aluminium à gravité, moulé sous pression, extrudé et en feuille.

Diffuseur: polycarbonate.

Ampoule: à incandescence, compactes intégrées, lampes à décharge, à led.

Vis: inox.

Câblage: douille porcelaine E27, fils téflon, bornier nylon.

Accessoires pour lampes à décharge sur demande.

Traitement: anticorrosion, électrophorèse cathodique.

Peinture: poudres polyester.

Application: murale avec boîtier et vis de fixation, plafonnier, lampadaire à un ou plusieurs luminaires.

Estructura: aluminio por gravedad y fundido a presión, extrusión y placa de aluminio.

Difusor: policarbonato.

Bombilla: incandescencia, compactas integradas, lámparas de descarga, led.

Tomillería: inox.

Cableado: portalámparas porcelana E27, hilos con teflon, bornera en nylon. Accesorios para lámparas de descarga sobre pedido.

Tratamiento: anticorrosivo, electroforesis catódica.

Pintado: polvos poliésteres.

Aplicación: en pared, con caja y tornillos de fijación, plafón, farolas solas o grupos para báculos.



54

ENOTECA
la pugliese
TRULLO CON
VEDUTA PANORAMICA

WINE
BAR

MODELLO 4X

IP23  

E27 Classe I 

LED 4, 6, 8W 

 ENERGY SAVING

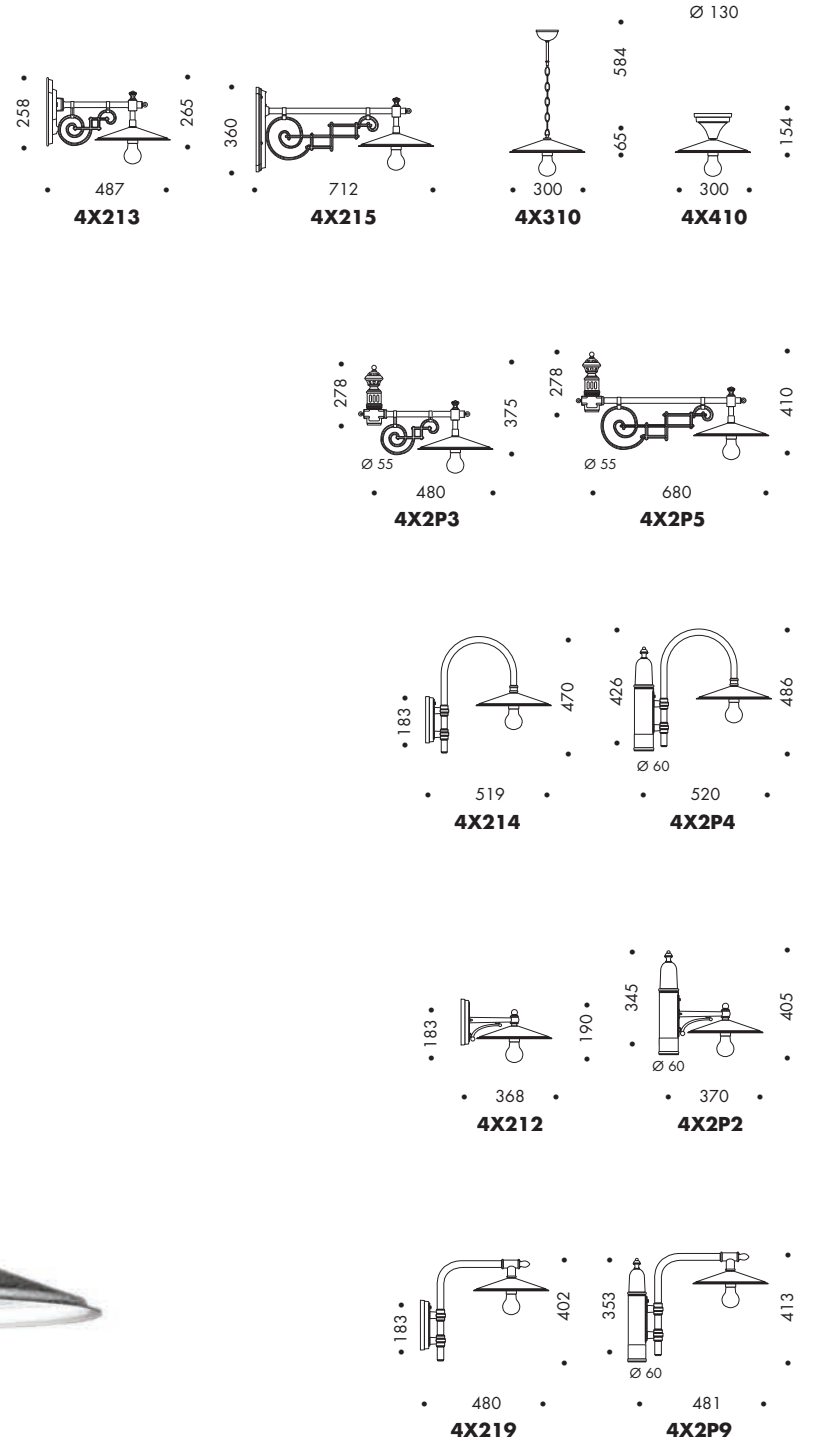



MODELLO 40

IP23

E27 Classe I

LED 4, 6, 8W

ENERGY SAVING

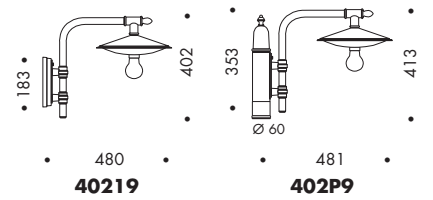
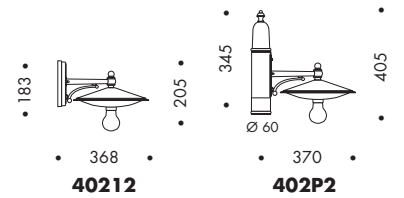
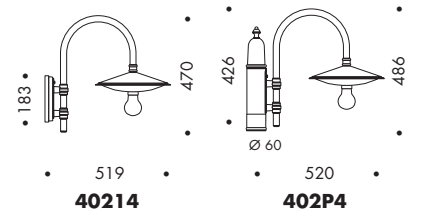
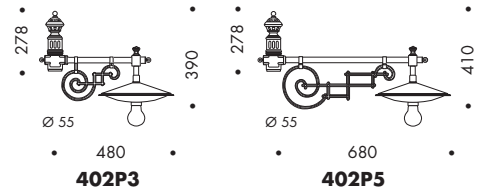
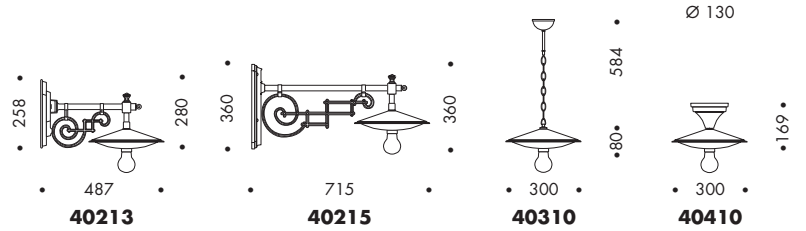



MODELLO 41

IP44 ▲ ▼ CE

IP43 ■ art. 41215

art. 41310

art. 41410

E27 Classe I ⊕

LED 4, 6, 8W

ENERGY SAVING

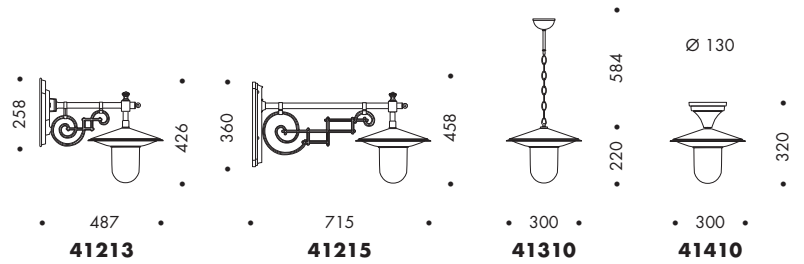

Ø 130

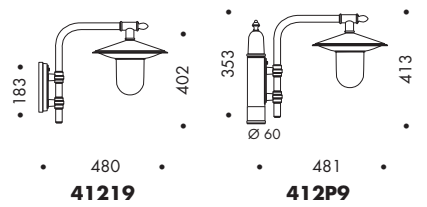
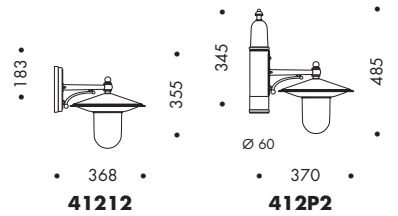
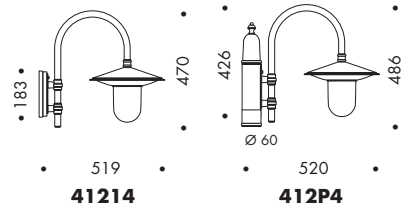
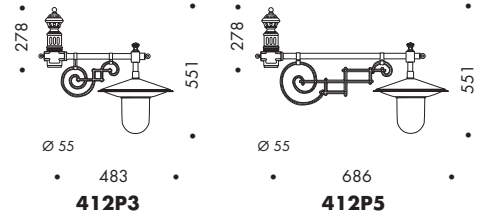



MODELLO G

IP43  

E27 Classe I 

LED 4, 6, 8W 

 ENERGY SAVING



G 001



G 002





G 003



G 004



MODELLO 42

IP23

E27 Classe I

LED 4, 6, 8W

ENERGY SAVING

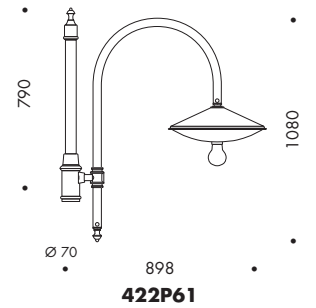
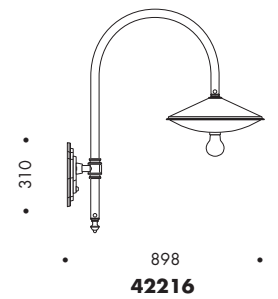
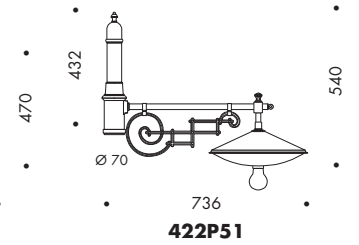
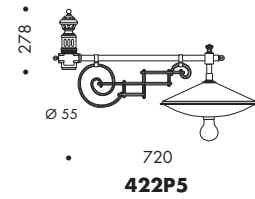
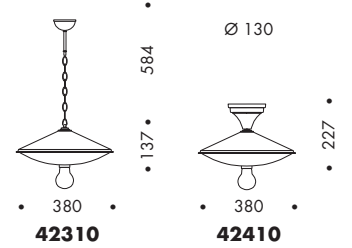
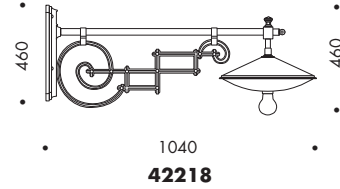
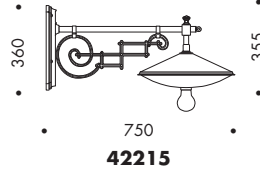



MODELLO 43

IP44 ▲ ▼ CE

IP43 ■ art. 43215/43218
art. 43310/43410

E27 Classe I ⊖ Classe II □

LED 4, 6, 8W 🗨️

💡 ENERGY SAVING

