

Struttura: alluminio a gravità e pressofuso.

Diffusore: in vetro soffiato, vetro a lastra.

A richiesta globo in PMMA.

Lampada: incandescenza, compatte integrate, led.

Viteria: inox.

Cablaggio: portalampade porcellana E27, fili in teflon, morsetti in nylon.

Trattamento: anticorrosivo, elettroforesi catodica.

Verniciatura: polveri poliesteri.

Applicazione: a muro con scatola e viti di fissaggio, a soffitto, a palo singola e gruppi.

Structure: gravity diecast and diecast aluminium.

Diffuser: blown or panel glass. PMMA globe available.

Bulb: incandescent, integrated compact, led lamp.

Fasteners: stainless steel.

Wiring: E27 porcelain lampholder, teflon covered wires, nylon terminal block.

Coating: anti-corrosion, cathodic electrophoretic.

Paint finish: polyester powder.

Applications: wall-mounted with box and fixing screws, ceiling-mounted, single or multiple for posts.

Struktur: Aluminium-Schwerkraftguss und-druckguss.

Diffusor: geblasenes Glas oder Glasscheiben.

PMMA-Kugel verfügbar.

Lampe: Glühlampen, kompakt integriert, Ledlampen.

Schrauben: Edelstahl.

Verkabelung: Porzellan-Lampenfassung E27, Teflonleitungen, Klemmleiste aus Nylon.

Behandlung: Korrosionsschutz, kathodische Elektrophorese.

Lackierung: Polyesterpulver.

Anwendung: Wandinstallation mit Gehäuse und Befestigungsschraube, Deckeninstallation, Mast-Einzelleuchte oder-gruppen.

Structure: aluminium à gravité et moulé sous pression.

Diffuseur: verre soufflé ou plaque. Boule PMMA sur demande.

Ampoule: à incandescence, compactes intégrées, à led.

Vis: inox.

Câblage: douille porcelaine E27, fils téflon, bornier nylon.

Traitement: anticorrosion, électrophorèse cathodique.

Peinture: poudres polyester.

Application: murale avec boîtier et vis de fixation, plafonnier, lanterne individuelle ou groupes pour fûts.

Estructura: aluminio por gravedad y fundido a presión.

Difusor: vidrio soplado o laminado.

Globo PMMA sobre pedido.

Bombilla: incandescencia, compactas integradas, led.

Tornillería: inox.

Cableado: portalámparas porcelana E27, hilos con teflon, bornera en nylon.

Tratamiento: anticorrosivo, electroforesis catódica.



Pintado: polvos poliésteres.

Aplicación: en pared, con caja y tornillos de fijación, plafón, farolas solas o grupos para báculos.

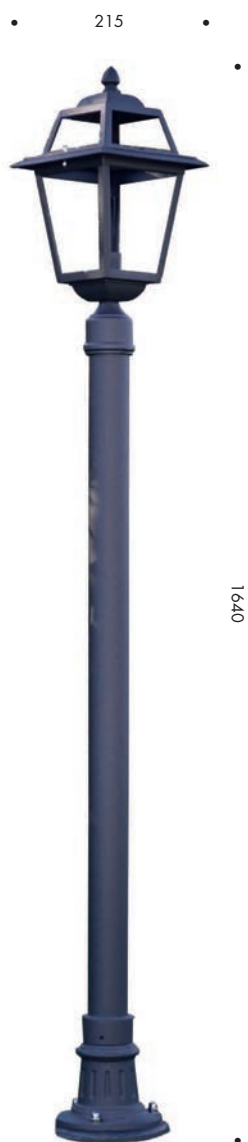
ART. S26525 + Palo P8



MODELLO S26

IP23   
 E27 Classe I 
 IAA 100W 
 FBT 15W 
 LED 5W 



S26110



S26310



S26211



MODELLO 26

IP44 ▲ ▼ CE Ⓜ
IP43 □ art. 26310
art. 26410

E27 Classe I ⊕

LED 4, 6, 8W

💡 ENERGY SAVING



S26410



S26420



S26530



S26022 + Palo P8



MODELLO S27

IP44 ▲ ▼ CE Ⓜ

IP43 □ art. 27310

art. 27410

E27 Classe I ⊕

LED 4, 6, 8W ⚡

💡 ENERGY SAVING



S27410



S27420



S27530





S27110



248

402



S27310



S27210



248

402



160

330

584

S27022 + Palo P8



MODELLO S27

IP44 ▲ ▼ CE Ⓢ

IP43 □ art. 27310

art. 27410

E27 Classe I ⊕

LED 4, 6, 8W 🔊

💡 ENERGY SAVING



S27210



402

248



S27212



432

254

ART. S2752S + Palo P8

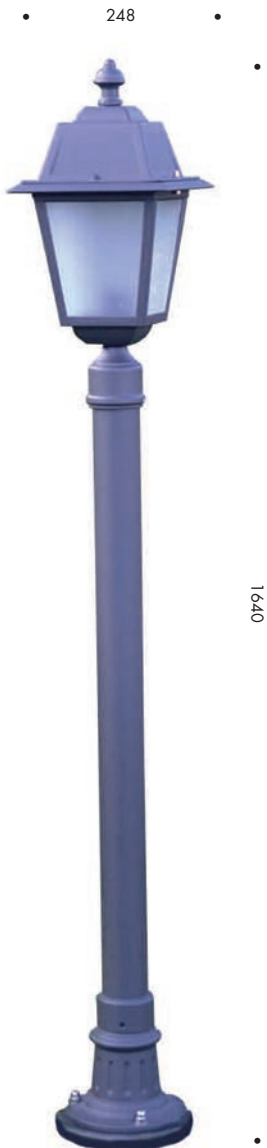

LANTERNE
small lanterns / die kleinen Laternen / lanternes petites / farolos pequenos

MODELLO 32

IP23   

E27 Classe I 

LED 5W 

 ENERGY SAVING



S32210



S32212



S32221

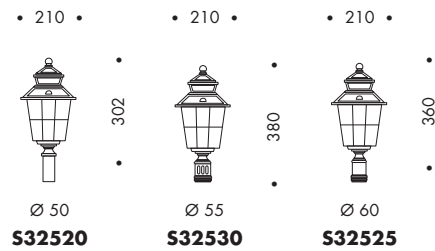
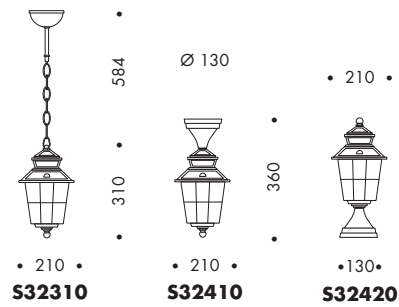
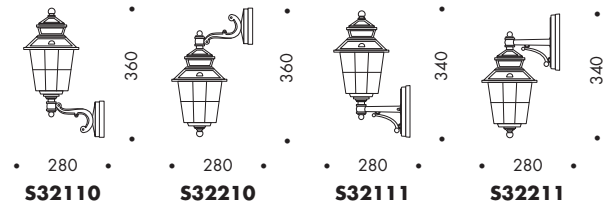



280

S32525 + Palo P8

1560



630

490

S32022 + Palo P8

2390



S32420