

Struttura: alluminio a gravità e pressofuso.

Diffusore: in vetro soffiato, vetro a lastra.

A richiesta globo in PMMA.

Lampada: incandescenza, compatte integrate ed a luce miscelata, led.

Viteria: inox.

Cablaggio: portalampade porcellana E27, fili in teflon, morsettiera in nylon.

Trattamento: anticorrosivo, elettroforesi catodica.

Verniciatura: polveri poliesteri.

Structure: gravity diecast and diecast aluminium.

Diffuser: blown or panel glass. PMMA globe available.

Bulb: incandescent, integrated compact and blended mercury bulbs, led lamp.

Fasteners: stainless steel.

Wiring: E27 porcelain lampholder, teflon covered wires, nylon terminal block.

Coating: anti-corrosion, cathodic electrophoretic.

Paint finish: polyester powder.

Struktur: Aluminium-Schwerkraftguss und-druckguss.

Diffusor: geblasenes Glas oder Glasscheiben.

PMMA-Kugel verfügbar.

Lampe: Glühlampen, kompakt integriert und Mischlichtlampen, Ledlampen.

Schrauben: Edelstahl.

Verkabelung: Porzellan-Lampenfassung E27, Teflonleitungen, Klemmleiste aus Nylon.

Behandlung: Korrosionsschutz, kathodische Elektrophorese.

Lackierung: Polyesterpulver.

Structure: aluminium à gravité et moulé sous pression.

Diffuseur: verre soufflé ou plaque. Boule PMMA sur demande.

Ampoule: à incandescence, compactes intégrées et mercure mixte, à led.

Vis: inox.

Câblage: douille porcelaine E27, fils téflon, bornier nylon.

Traitement: anticorrosion, électrophorèse cathodique.

Peinture: poudres polyester.

Estructura: aluminio por gravedad y fundido a presión.

Difusor: vidrio soplado o laminado. Globo PMMA sobre pedido.

Bombilla: incandescencia, compactas integradas y de luz mezcla, led.

Tornillería: inox.

Cableado: portalámparas porcelana E27, hilos con teflon, bornera en nylon.

Tratamiento: anticorrosivo, electroforesis catódica.

Pintado: polvos poliésteres.

ART. 291-2 + Palo P8

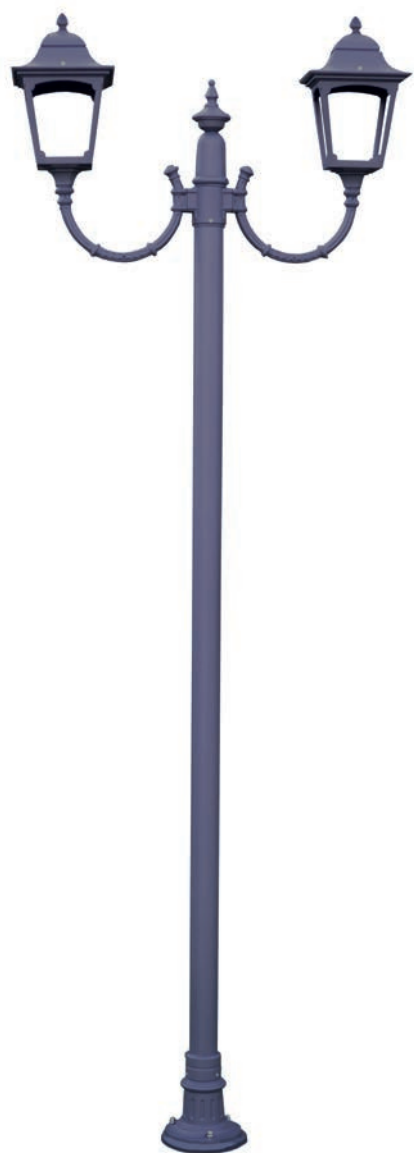

2480



GRUPPI LANTERNE MEDIE

medium lantern groups / Mittlere Laternen-Gruppen / moyenne gamme a plusieurs tetes / grupos de farolos medias

IP23

IP43 con fondello in policarbonato trasparente

E27 Classe I

LED 6, 8, 12, 14W

ENERGY SAVING

I modelli sono intercambiabili, per una migliore comprensione delle composizioni abbiamo esemplificato usando il modello 50. È possibile avere gli stessi gruppi ottici con i modelli 51/52/53/54/55/56/57/58/59/70.

50020 → **500204**
Ø 55 → Ø 50
→ **500202**
Ø 60

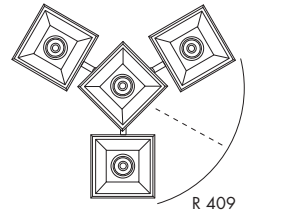
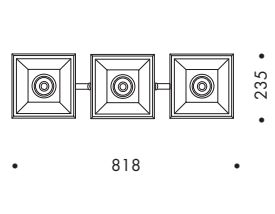
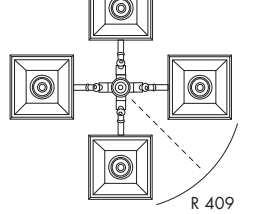
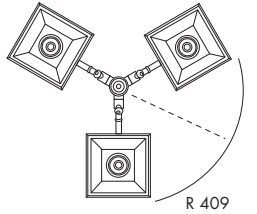
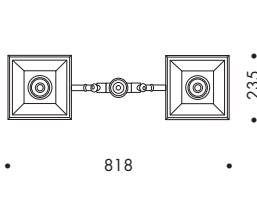
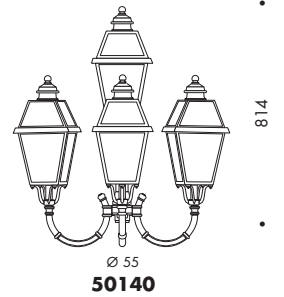
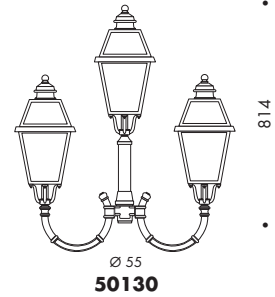
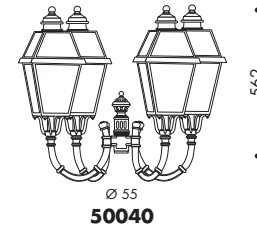
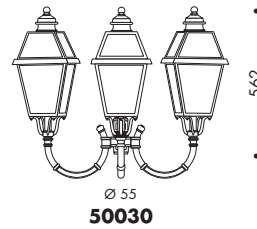
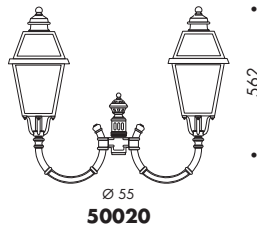

Heads are interchangeable, for a better comprehension we suggested model 50 but arrangements are available with all models 51/52/53/54/55/56/57/58/59/70.

Im Katalog haben wir zur Vereinfachung die Modelle 50, als Beispiel, abgebildet. Es können jedoch auch die Modelle 51/52/53/54/55/56/57/58/59/70 verwendet werden.

Les modèles sont interchangeables, pour simplifier nous avons présenté le modèle 50 mais la même application peut se faire avec les modèles 51/52/53/54/55/56/57/58/59/70.

Los modelos son intercambiables. Para una mejor comprensión de las composiciones, hemos realizado un ejemplo con el modelo 50. Es posible tener los mismos grupos ópticos con los modelos 51/52/53/54/55/56/57/58/59/70.

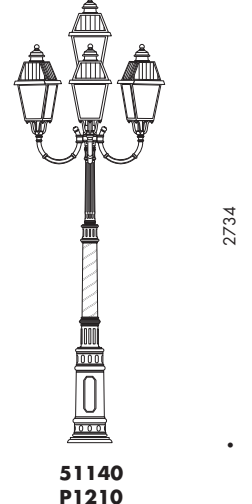
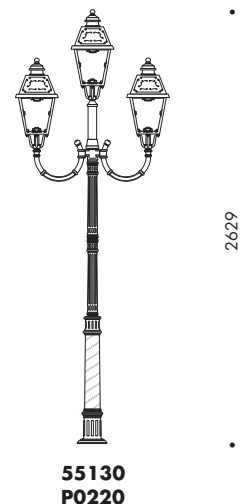
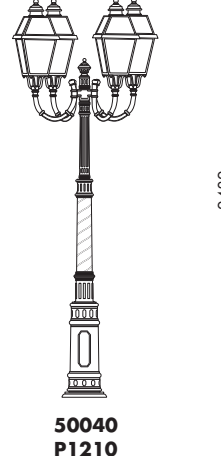
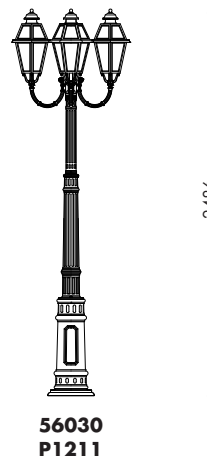
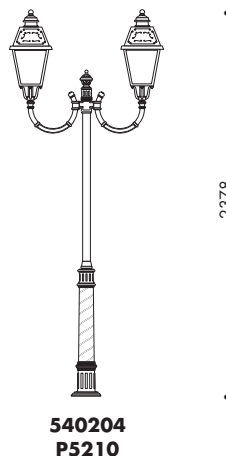

IP23
 IP43 con fondello in
 policarbonato trasparente
 E27 Classe I
 LED 6, 8, 12, 14W
 ENERGY SAVING

I modelli sono intercambiabili, per una migliore comprensione delle
 composizioni abbiamo esemplificato usando il modello 50.
 È possibile avere gli stessi gruppi ottici con i modelli
 51/52/53/54/55/56/57/58/59/70.

50023 → **500234**
 Ø 55 → Ø 50
 → **500232**
 Ø 60

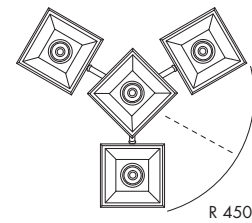
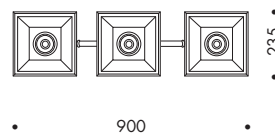
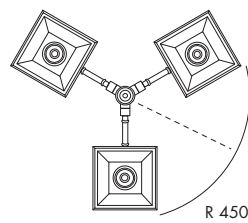
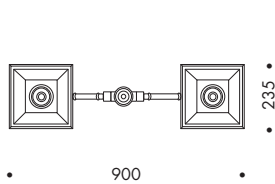
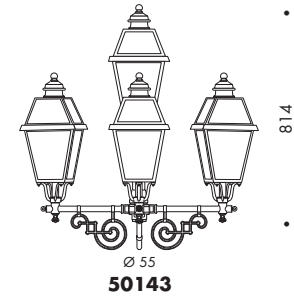
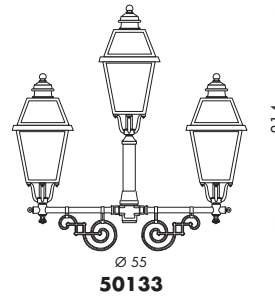
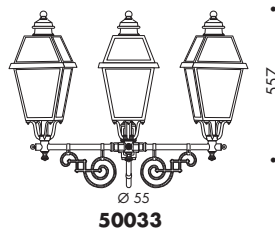
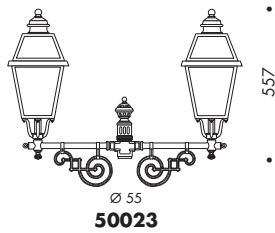

Heads are interchangeable, for a better
 comprehension we suggested model
 50 but arrangements are available
 with all models
 51/52/53/54/55/56/57/58/59/70.

Im Katalog haben wir zur
 Vereinfachung die Modelle 50, als
 Beispiel, abgebildet.
 Es können jedoch auch die Modelle
 51/52/53/54/55/56/57/58/59/70
 verwendet werden.

Les modèles sont interchangeables,
 pour simplifier nous avons présenté
 le modèle 50 mais la même application
 peut se faire avec les modèles
 51/52/53/54/55/56/57/58/59/70.

Los modelos son intercambiables.
 Para una mejor comprensión de las
 composiciones, hemos realizado un
 ejemplo con el modelo 50.
 Es posible tener los mismos grupos
 ópticos con los modelos
 51/52/53/54/55/56/57/58/59/70.

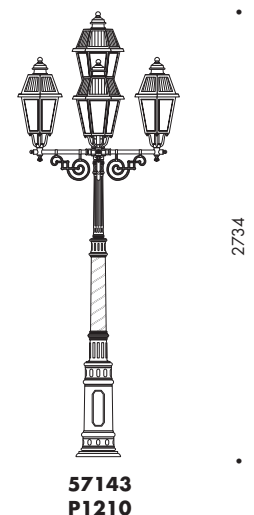
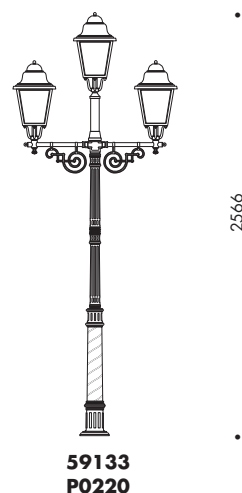
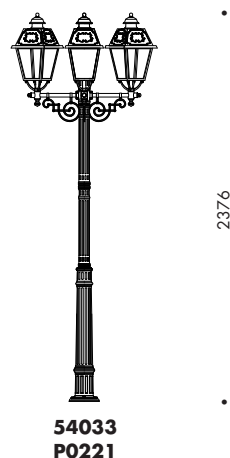
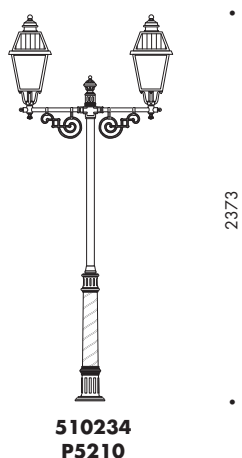

IP23

IP43 con fondello in

policarbonato trasparente

E27 Classe I

LED 6, 8, 12, 14W

ENERGY SAVING

I modelli sono intercambiabili, per una migliore comprensione delle composizioni abbiamo esemplificato usando il modello 50. È possibile avere gli stessi gruppi ottici con i modelli 51/52/53/54/55/56/57/58/59/70.

502P4 **502P43**
 Ø 60 Ø 55

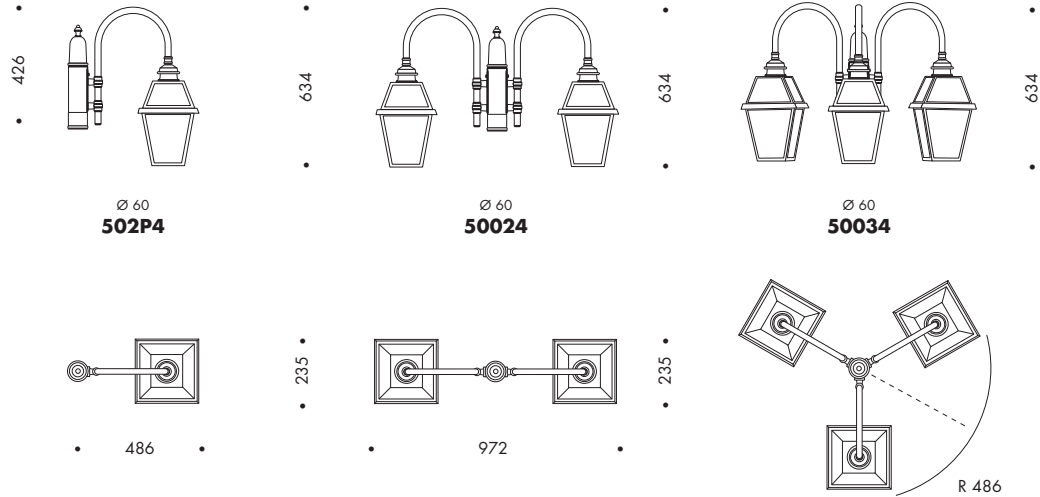

Heads are interchangeable, for a better comprehension we suggested model 50 but arrangements are available with all models 51/52/53/54/55/56/57/58/59/70.

Im Katalog haben wir zur Vereinfachung die Modelle 50, als Beispiel, abgebildet. Es können jedoch auch die Modelle 51/52/53/54/55/56/57/58/59/70 verwendet werden.

Les modèles sont interchangeables, pour simplifier nous avons présenté le modèle 50 mais la même application peut se faire avec les modèles 51/52/53/54/55/56/57/58/59/70.

Los modelos son intercambiables. Para una mejor comprensión de las composiciones, hemos realizado un ejemplo con el modelo 50. Es posible tener los mismos grupos ópticos con los modelos 51/52/53/54/55/56/57/58/59/70.

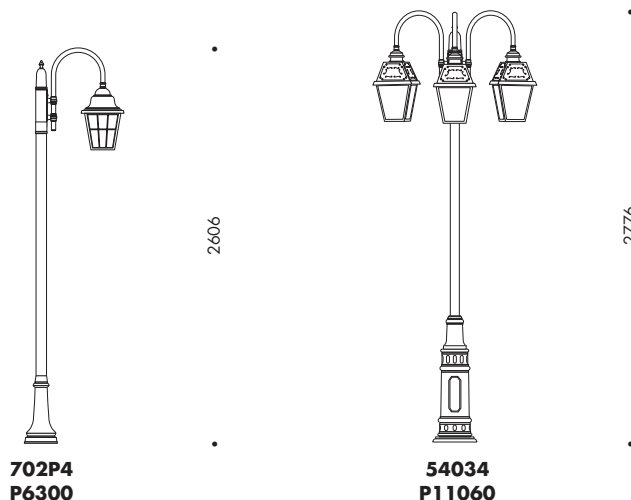



IP23

IP43 con fondello in

policarbonato trasparente

E27 Classe I

LED 6, 8, 12, 14W

ENERGY SAVING

I modelli sono intercambiabili, per una migliore comprensione delle composizioni abbiamo semplificato usando il modello 50. È possibile avere gli stessi gruppi ottici con i modelli 51/52/53/54/55/56/57/58/59/70.

501P2 **501P3**
 Ø 60 → Ø 55

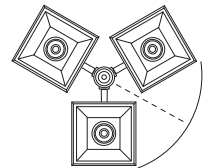
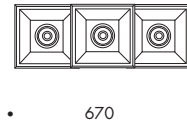
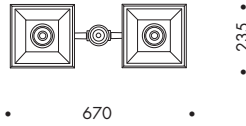
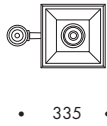
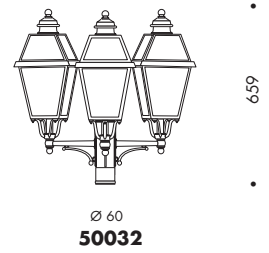
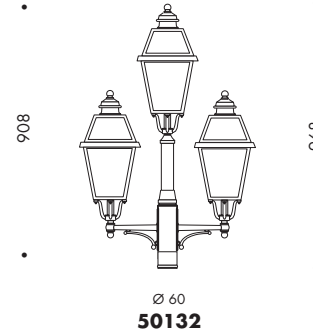
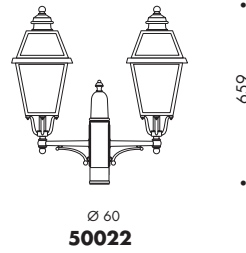
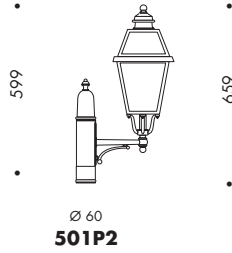

R 335

Heads are interchangeable, for a better comprehension we suggested model 50 but arrangements are available with all models 51/52/53/54/55/56/57/58/59/70.

Im Katalog haben wir zur Vereinfachung die Modelle 50, als Beispiel, abgebildet. Es können jedoch auch die Modelle 51/52/53/54/55/56/57/58/59/70 verwendet werden.

Les modèles sont interchangeables, pour simplifier nous avons présenté le modèle 50 mais la même application peut se faire avec les modèles 51/52/53/54/55/56/57/58/59/70.

Para una mejor comprensión de las composiciones, hemos realizado un ejemplo con el modelo 50. Es posible tener los mismos grupos ópticos con los modelos 51/52/53/54/55/56/57/58/59/70.

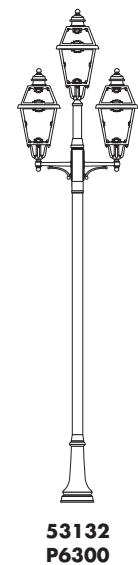
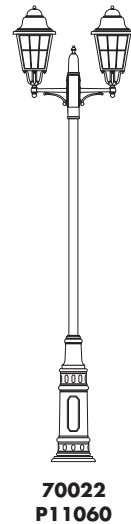
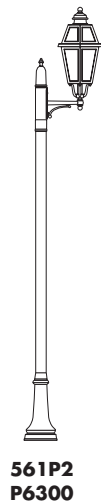

GRUPPI LANTERNE MEDIE

medium lantern groups / Mittlere Laternen-Gruppen / moyenne gamme a plusieurs tetes / grupos de farolas medias

